

# WA 77 AUTOMATIC SPRAY GUN

**GB** Before use, adjustment or maintenance, it is important to read this instruction manual very carefully. This manual must be stored in a safe place for any future reference that may be necessary.

This **ANEST IWATA** spray guns kit complies to ATEX regulations 94/9/EC  
Protection level: II 2 G X Suitable for using in Zones 1 and 2.  
X marking: Any static electricity discharge from the spray gun is to be diverted to the ground via the conductive air hose as stipulated.



## IMPORTANT

This automatic spray gun should be operated only by an adequately trained operator for safe use and maintenance of the equipment. Any misuse or handling other than those indicated in this Instruction Manual is not covered by guarantee.



**ANEST IWATA** disclaims all responsibility for any accident or damage caused by failure observing the operational and safety procedures as from this manual. In the interest of user friendliness, this manual contains information in a brief and concise form.

For any additional information you may require regarding the automatic spray gun operations, or if any missing parts or any damage during transportation is found, or details of training courses, please contact your nearest **ANEST IWATA Company** (see last cover page).

Be sure to observe warnings and cautions in this instruction manual.

If not, it can cause paint ejection and serious bodily injury by drawing organic solvent.

Be sure to observe following  marked items which are especially important.

 <b>WARNING</b>	Indicates a potentially hazardous situation which, if not avoided, may result in serious injury or loss of life.
 <b>CAUTION</b>	Indicates a potentially hazardous situation which, if not avoided, may result in minor or moderate injury or property damage.
<b>IMPORTANT</b>	Indicates notes which we ask you to observe. The safety precautions in this instruction manual are the minimum necessary conditions. Follow national and local regulations regarding fire prevention, electricity and safety as well as your own company regulations.

## IMPORTANT SPECIFICATIONS

Max. Pressure:	6.8 bar (98 PSI)	Max. Temperature:	
Spray conditions	Recommended	Atmosphere	5 ~ 40 °C
Measuring point	1m backwards from gun, 1,6 m height	Air and fluid	5 ~ 43 °C
Noise Level (LAeqT)	82.1 dB (A)	Air connection:	G 1/4"
		Fluid connection:	G 1/4"

## TECHNICAL SPECIFICATIONS

Model	Fluid nozzle mm (in)	Air Cap Set	*Atomizing air pressure bar (PSI)	Fluid output ml/m	Air consumption l/m (cfm)	Pattern width mm	Weight (in) g
<b>WA-77 Pressure feed</b>							
WA-77-081P	0.8 (0.031)	0	3.5 (49)	280	450 (15.9)	310 (12.2)	620
WA-77-101P	1.0 (0.039)			380		390 (15.3)	
WA-77-121P	1.2 (0.047)			480		445 (17.5)	
WA-77-152P	1.5 (0.059)	11	285	310 (10.9)	290 (11.4)		
WA-77-251P	2.5 (0.098)	3	485	345 (12.2)	330 (13.0)		

**NOTE:** \*Atomizing air pressure means pressure at gun inlet when piston is pulled and air flows.

Manufactured by:

**ANEST IWATA Corporation** 3176, Shinyoshida-cho, Kohoku-ku, Yokohama, 223-8501 Japan



**ANEST IWATA Europe S.r.l.**  
46, Corso Vigevano 10155, Torino Italy  
Direct Tel. +39 011 - 22 74 402  
Fax +39 011 - 22 74 406  
info@anest-iwataeu.com  
www.anest-iwataeu.com



**ANEST IWATA Italia S.r.l.**  
46, Corso Vigevano 10155, Torino (Italy)  
Tel. diretto +39 011 - 24 80 868 - Fax: +39 011 - 85 19 44  
info@anest-iwata.it [www.anest-iwata.it](http://www.anest-iwata.it)

**ANEST IWATA Iberica**  
Calle de Les Teixidores, 3-5  
08918 - Badalona (Barcelona)  
Tel.: +34 933 20 59 93 - Fax.: +34 933 20 59 65  
info@anest-iwata.es [www.anest-iwata.es](http://www.anest-iwata.es)

**ANEST IWATA Europe S.r.l.**  
NIEDERLASSUNG DEUTSCHLAND  
Dorfäckerstr. 23/1, 74248 Ellhofen  
Telefon: +49 (0) 7134- 917368 - Fax: +49 (0) 7134 - 917378  
Handy: +49 (0) 172 - 62 74 542  
info@anest-iwata.de [www.anest-iwata.de](http://www.anest-iwata.de)

## European Sales Branches:







**ANEST IWATA Scandinavia**  
Ögärdesvägen 6C, 433 30 PARTILLE - Sweden  
Tel. +46 (0)31 - 340 28 60 - Fax +46 (0)31 - 340 28 69  
info@anest-iwata.se [www.anest-iwata.se](http://www.anest-iwata.se)

**ANEST IWATA France**  
25 rue de Madrid - 38070 St Quentin Fallavier - France  
Tél. +33 (0)4 - 74 94 59 69 - Fax +33 (0)4 - 74 94 34 39  
info@anest-iwata.fr [www.anest-iwata.fr](http://www.anest-iwata.fr)

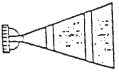
**ANEST IWATA U.K.**  
Unit 10 Little End Road - Eaton Socon  
St. Neots - CAMBRIDGESHIRE  
PE19 8JH  
Tel.: +44 (0) 1480 405419 Fax: +44 (0) 1480 217610  
enquiries@anest-iwata.co.uk [www.anest-iwata.co.uk](http://www.anest-iwata.co.uk)



# TROUBLESHOOTING

Spray Pattern	Problems	Remedies
 Fluttering	1. Air enters between fluid nozzle and tapered seat of gun body. 2. Air is drawn from fluid needle packing set 3. Air enters at fluid container fitting nut or fluid hose joint.	1. Remove fluid nozzle to clean seat. If it is damaged, replace nozzle. 2. Tighten fluid needle packing. 3. Fully tightening joint sections.
 Crescent	1. Paint buildup on air cap partially clogs horn holes. Air pressure from both horns differs.	1. Remove obstructions from horn holes with attached brush. But do not use metal objects to clean horn holes.
 Inclined	1. Paint buildup or damage on fluid nozzle circumference and air cap center. 2. Fluid nozzle is not properly fitted.	1. Remove obstructions. Replace if damaged. 2. Remove fluid nozzle, clean seated section
 Split	1. Paint viscosity too low. 2. Fluid output too high.	1. Add paint to increase viscosity. 2. Tighten fluid adj. knob to reduce fluid output or turn pattern adj. knob clockwise.
 Heavy Center	1. Paint viscosity is too high. 2. Fluid output is too low.	1. Add thinner to reduce viscosity. 2. Turn fluid adj. knob counter-clockwise to increase fluid output.
 Spit	1. Fluid nozzle and fluid needle set are not seated properly. 2. The first-stage travel of trigger (when only air discharges) decreases. 3. Paint buildup inside air cap set.	1. Clean or replace fluid nozzle and fluid needle set. 2. Replace fluid nozzle and fluid needle set. 3. Clean air cap set.

# PROBLEMS AND REMEDIES

Problem	Where it occurred	Parts to be checked	Cause	Remedy			
				Tighten	Adjust	Clean	Replace
Air leaks (from tip of air cap)	Piston	Piston	*Dirt or damage wear on seat surface			x	x
		Air valve seat set	*Dirt or damage on seat *Wear on air valve spring			x	x
		O ring	*Damaged or deteriorated				x
Paint leaks	Fluid nozzle	Fluid nozzle - fluid needle set	*Dirt, damage, wear on seat			x	x
			*Loose fluid needle adj. knob		x		
			*Wear on needle spring				x
		Fluid nozzle - gun body	*Insufficient tightening	x			
	*Dirt or damage on seat				x	x	
	Fluid needle packing set - needle set	*Needle does not return due to packing set too tight			x		x
*Needle does not return due to paint buildup on fluid needle				x	x		
Fluid needle	Needle packing set, needle set	*Wear	x			x	
	Packing seat	*Insufficient tightening	x				
Paint does not flow	Tip of gun	Fluid adj. knob	*Insufficient opening		x		
		Tip hole of nozzle	*Clogged			x	
		Paint filter	*Clogged			x	x

# HOW TO CONNECT



## CAUTION

- Use clean air filtered through air dryer and air filter. If not, dirty air can cause painting failure.
- When you use this gun for the first time after purchasing, clean fluid passages spraying thinner and remove rust preventive oil. If not, remaining preventive oil can cause painting failure such as fish eyes.
- Use three-way solenoid valve of more than  $\phi 4$  inner dia. cross-sectional area and air hose of over  $\phi 6$  inner diameter and less than 10m length. If not, small diameter of solenoid valve and longer air hose between three-way solenoid valve and gun can cause delay in operation.
- Firmly fix hose to spray gun. If not, disconnection of hose and drop of container can cause bodily injury.

1. Fit the gun to fitting stay, aim at spraying direction and fix it..
2. Connect atomizing air hose to atomizing air side (Cap marked side) and operating air hose to operating air side (CYL marked side).
3. Connect fluid hose to fluid inlet side.
4. Pour paint into container, test spray and adjust fluid output as well as pattern width
5. Pour paint into fluid container, test spray and adjust fluid output, air volume and pattern width.

## (CONNECTION EXAMPLE OF AIR HOSE AND FLUID HOSE)

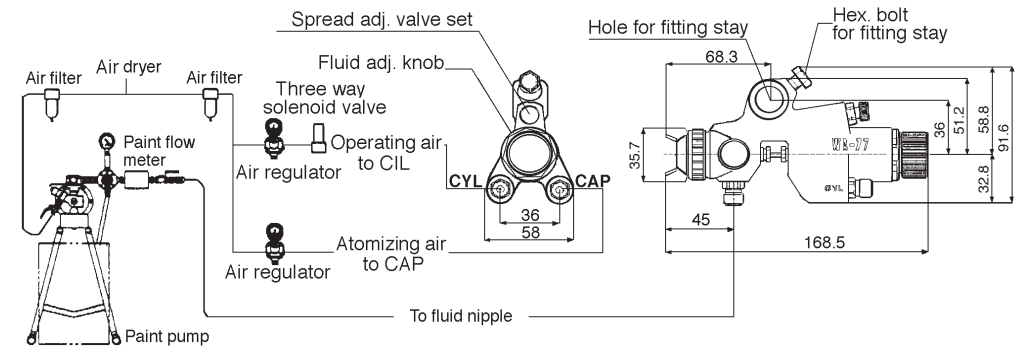

## When you use half union sold on the market

Fit half union ( $\phi 6$  mm) to CYL marked side and half union ( $\phi 8$  mm) to CAP marked side. Use air hose of ( $\phi 6$  mm) to operate piston and air hose of ( $\phi 8$  mm) to atomize air

# HOW TO OPERATE

Although atomizing air pressure varies according to viscosity and property of paint set it about 3.5 bar (49 PSI)

Recommended paint viscosity differs according to paint property and painting conditions, 15 ~ 23 sec Ford cup #4. is recommended.

Set the spray distance from the gun to the workpiece as near as possible within in the range of 200~250 mm (8-10 in).

The gun should be held so that it is perpendicular to the surface of the work piece at all times. Then, the gun should move in a straight and horizontal line. Arcing the gun causes uneven painting.

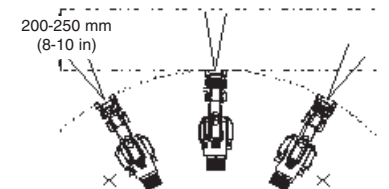

# MAINTENANCE AND INSPECTION



## WARNING

- First release air and fluid pressure fully according to item No. 3 of "Improper use of equipment" of WARNING on page 2.
- Tip of fluid needle set has a sharp point. Do not touch the tip of needle during maintenance for protection of the human body.
- Be careful not to damage the tip of the fluid nozzle or put your hand on it.
- Only an experienced person who is fully conversant with the equipment can do maintenance and inspection.



## CAUTION

- Never use commercial or other parts instead of ANEST IWATA original spare parts.
- Never immerse the whole gun into liquid such as thinner.
- Never damage holes of air cap, fluid nozzle or fluid needle.

### Step-by-step procedure

1. Pour remaining paint to another container. Clean fluid passages and air cap set.  
Spray a small amount of thinner to clean fluid passages.

2. Clean each section with brush soaked with thinner and wipe out with waste cloth.

3. Before disassembly, fully clean fluid passages.

(1) Disassemble fluid nozzle.

Use ring spanner, box wrench or optional exclusive spanner to disassemble fluid nozzle.

(2) Disassemble fluid needle set.

Remove fluid adj. set and pull out fluid needle set from gun body.

Pay attention so that spring does not suddenly fly out since fluid adj. set is strongly pushed by fluid needle spring and piston spring.

4. To adjust fluid needle packing set, while keeping fluid needle set inserted, tighten fluid needle packing seat by hand and then tighten further by spanner. (1/12\_1/6 turn from hand tightening)

When replacing fluid needle packing set, be careful that the top old packing does not remain inside.

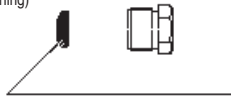

5. Turn pattern adj. knob counterclockwise to fully open. And then tighten pattern adj. guide into gun body.

6. Apply Vaseline or oil to thread section of fluid adj. set and insert it into gun body set while keeping it fully opened.

### Where to inspect

- Each hole passage of air cap and fluid nozzle
- Packing and O ring
- Leakage from seat section between fluid nozzle and fluid needle set

### Important

1. Incomplete cleaning can fail pattern shape and uniform particles.  
Especially clean fully and promptly after use with two-component paint .

2. Do not immerse the whole gun in thinner. If done, it can damage parts.  
When cleaning, never scratch any holes of air cap set, fluid nozzle, and fluid needle set.

3. During disassembly, do not scratch seat section.  
(1) Remove fluid nozzle after removing fluid needle set or while keeping fluid needle pulled, in order to protect seat section.  
(2) Pull fluid needle set after loosening fluid needle packing set to protect fluid needle packing set.

4. Too much tightening of fluid needle packing set can cause bad movement of fluid needle set and fluid leakage from the tip of fluid needle set.  
Adjust by turning on and off operating air while watching movement of fluid needle set.

5. If fluid adj. set is not fully opened, tip of it can contact and damage tip of gun body set and cause seizure of thread.

6. If fluid adj. set is not fully opened, tip seat section of it can contact and damage fluid nozzle and cause seizure of thread.

### Parts replacement standard

- Replace if it is crushed or deformed.
- Replace if it is deformed or worn out.
- Replace them if leakage does not stop after fully cleaning fluid nozzle and fluid needle set. If you replace fluid nozzle or fluid needle set only, fully match them and confirm that there is no leakage.

# SPARE PARTS LIST

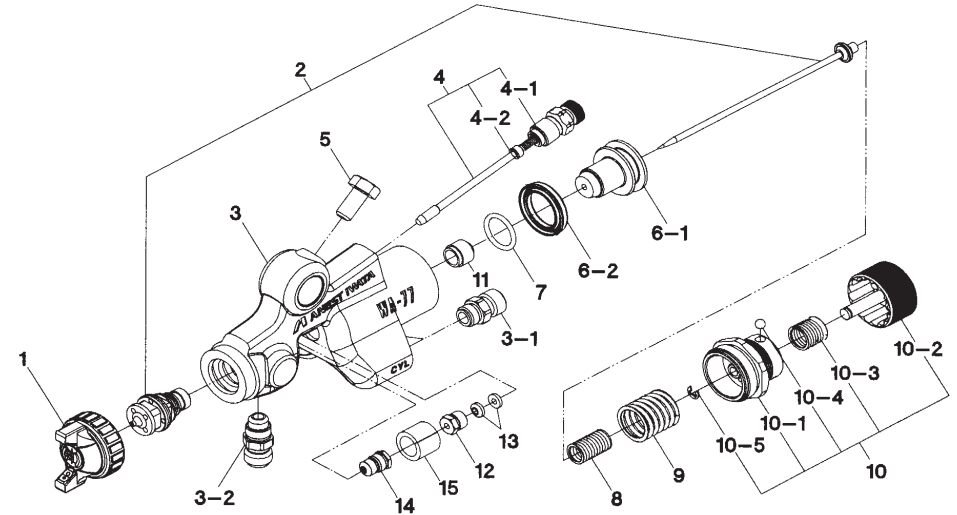

DESCRIPTION	REF. PART
AIR CAP SET	1
FLUID NOZZLE-NEEDLE SET	2 ●
BODY SET	3
AIR NIPPLE	3-1
FLUID NIPPLE	3-2
SPREAD ADJ. VALVE SET	4
O RING	4-1 ●
STOPPER	4-2
HEX. BOLT	5
PISTON	6-1
PISTON PACKING	6-2 ●
O RING	7 ●
NEEDLE SPRING	8
PISTON SPRING	9
FLUID ADJ. SET	10
FLUID ADJ. GUIDE SET	10-1
FLUID ADJ. KNOB	10-2
FLUID ADJ. SPRING	10-3
BALL	10-4
E STOPPER	10-5
NEEDLE PACKING HOLDER	11
NEEDLE PACKING NUT	12
NEEDLE PACKING SET	13
RULON PACKING	14
COVER	15

Model	Fluid nozzle		Fluid needle
	Orifice Ø mm (in)	Mark	Mark
WA 77 081P	0.8 (0.031)	77/08	12
WA 77 101P	1.0 (0.039)	77/10	12
WA 77 121P	1.2 (0.051)	77/12	12
WA 77 152P	1.5 (0.059)	77/15	15
WA 77 251P	2.5 (0.071)	77/25	25

### ● Marked parts are wearable parts.

- When ordering parts, specify gun's model, part name with ref. No, and marked No. of air cap set, fluid nozzle and fluid needle set.
- When opening package, check that there is no damage or missing parts.
- When there are missing parts or damage, do not use, and contact the shop which sold it to you.
- When replacing fluid nozzle or/and fluid needle for pressure feed application, please order nozzle needle set.